

Numbers 0 - 10

Get more worksheets at:
PrintyJoy.com

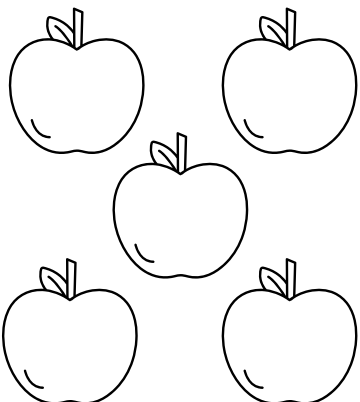

DIRECTION : Color the correct number of objects
in each picture



7 4 5

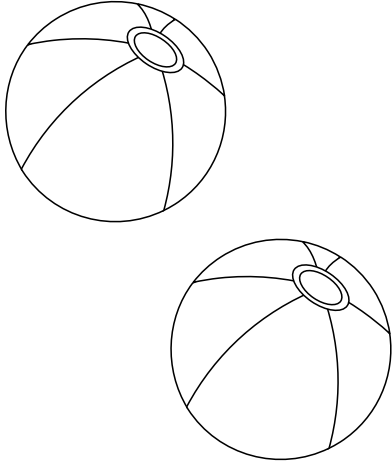

4 2 6

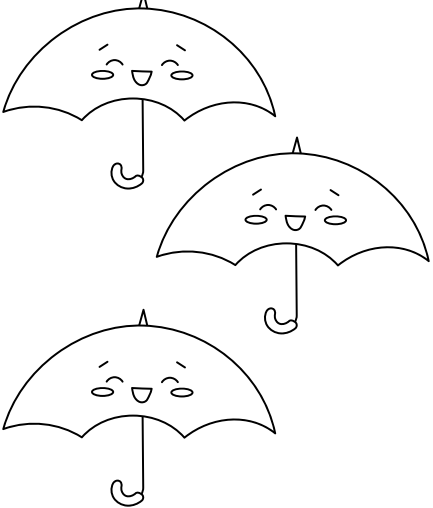

0 3 7

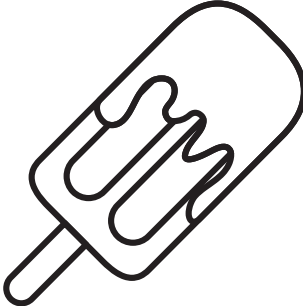

0 9 1



1 6 4

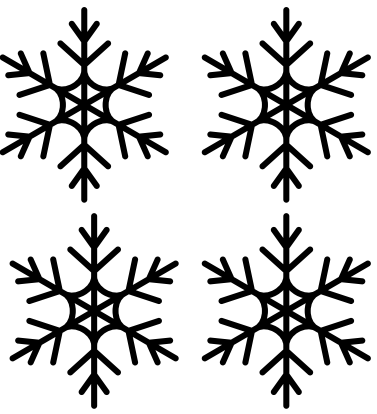

7 4 3

Numbers 0 - 10

Get more worksheets at:
PrintyJoy.com



DIRECTION : Color the correct number of objects in each picture

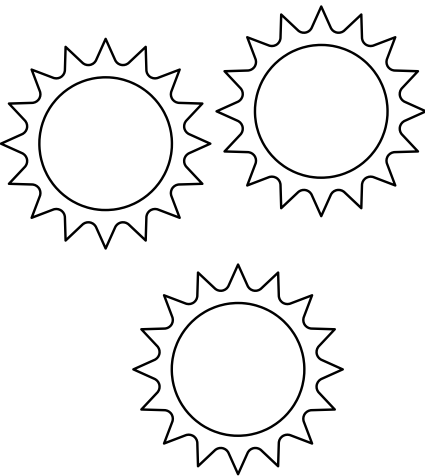

4 7 3



8 4 7

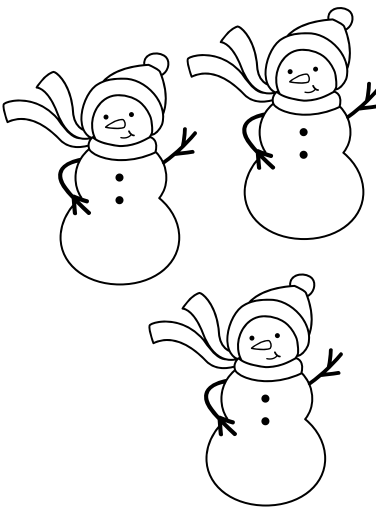

3 6 2

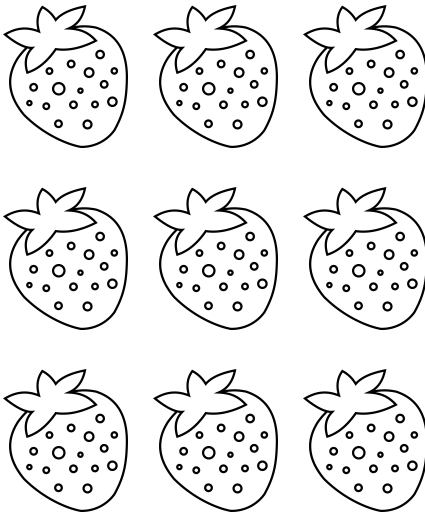

7 10 9

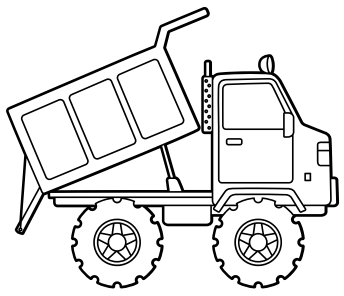

1 0 4

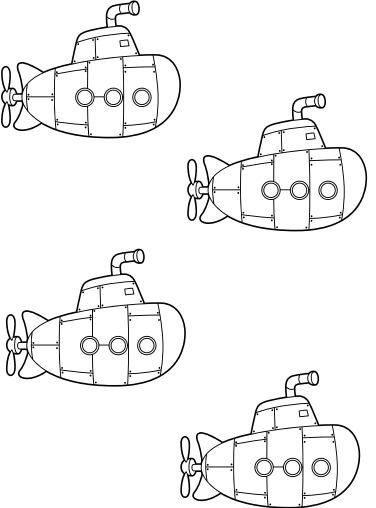

2 4 6

Numbers 0 - 10

Get more worksheets at:
PrintyJoy.com



DIRECTION : Color the correct number of objects in each picture

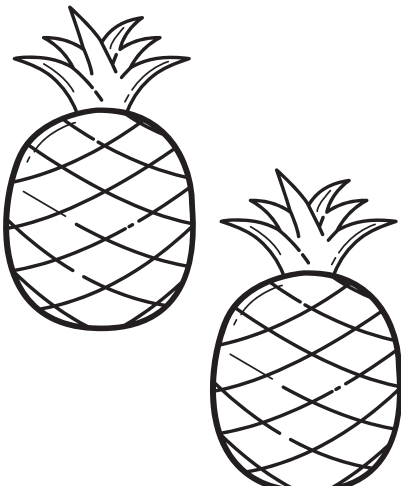

3 2 0

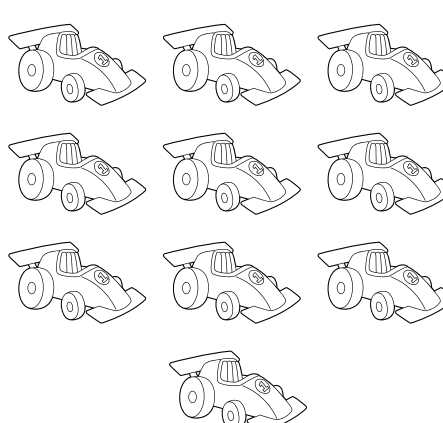

10 6 9



8 3 4

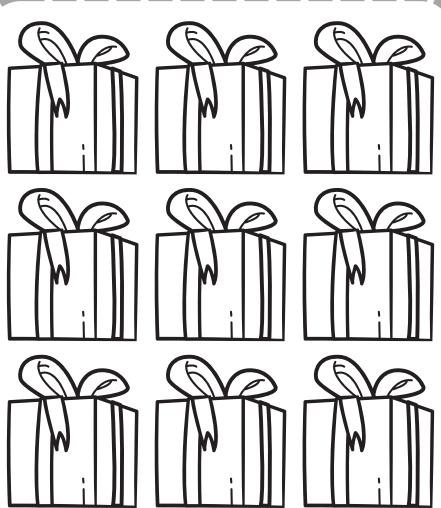

4 9 8

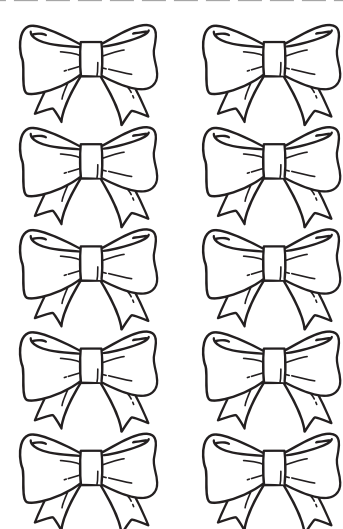

8 5 7

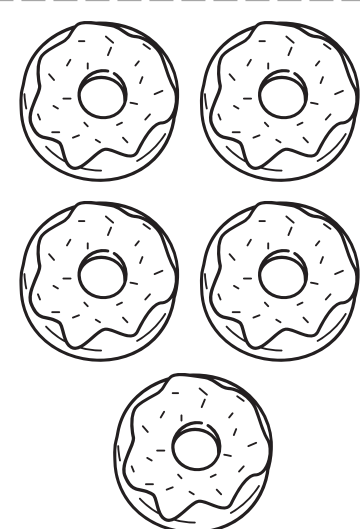

2 4 5

Numbers 0 - 10

Get more worksheets at:
PrintyJoy.com



DIRECTION : Color the correct number of objects in each picture

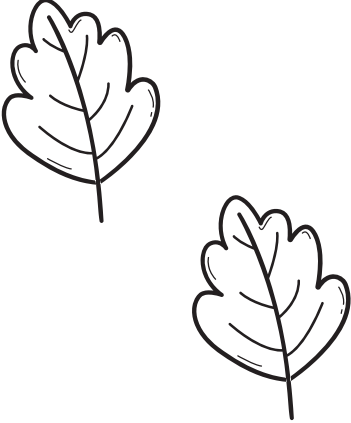

2 7 4

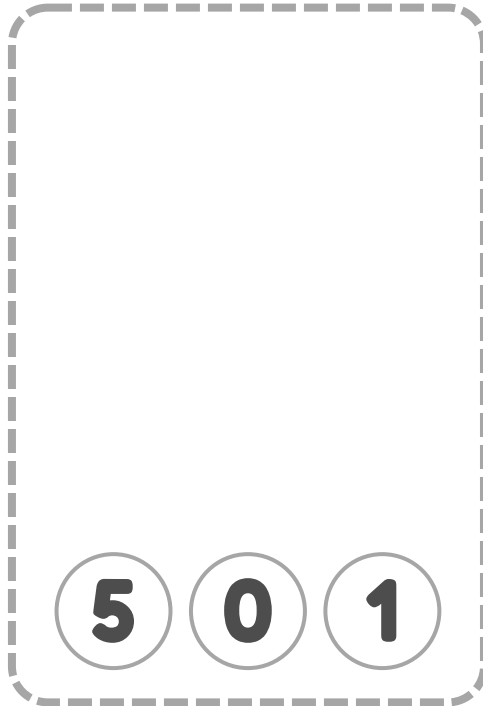

5 0 1

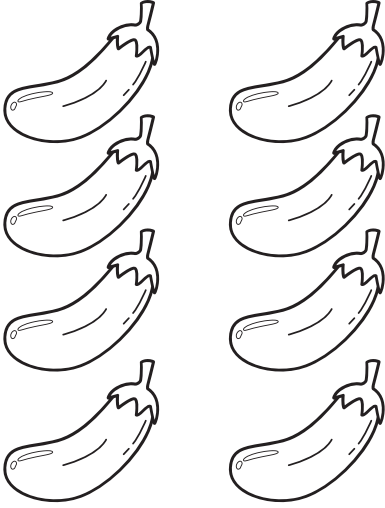

3 0 8

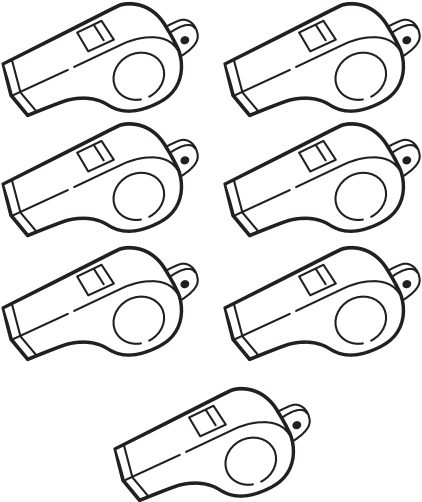

2 7 4

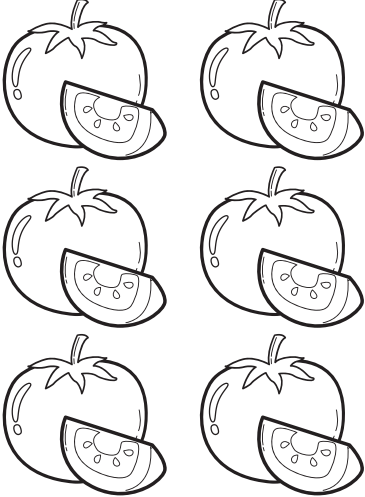

6 4 9

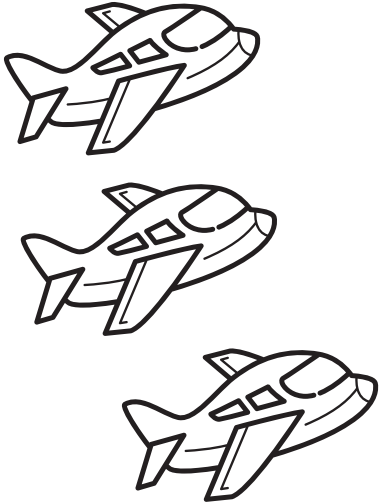

8 3 4

Numbers 0 - 10

Get more worksheets at:
PrintyJoy.com



DIRECTION : Color the correct number of objects
in each picture

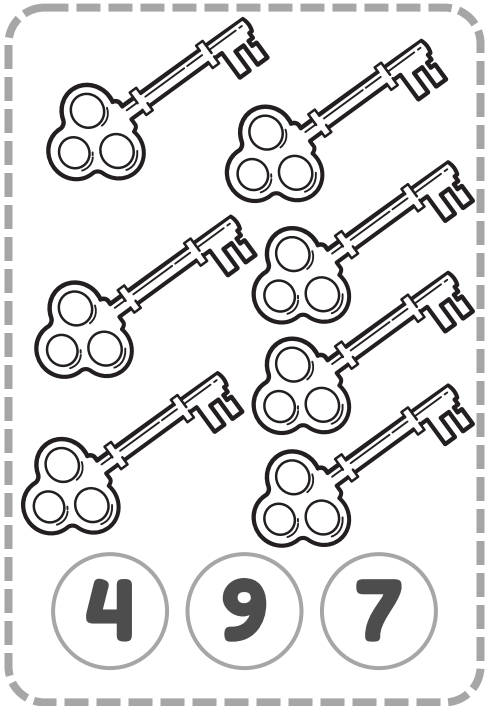

4 9 7



0 1 3

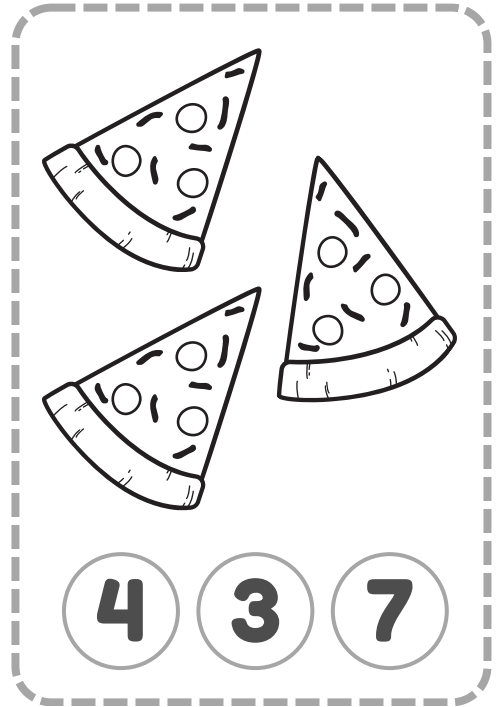

4 3 7



5 4 0



4 7 2

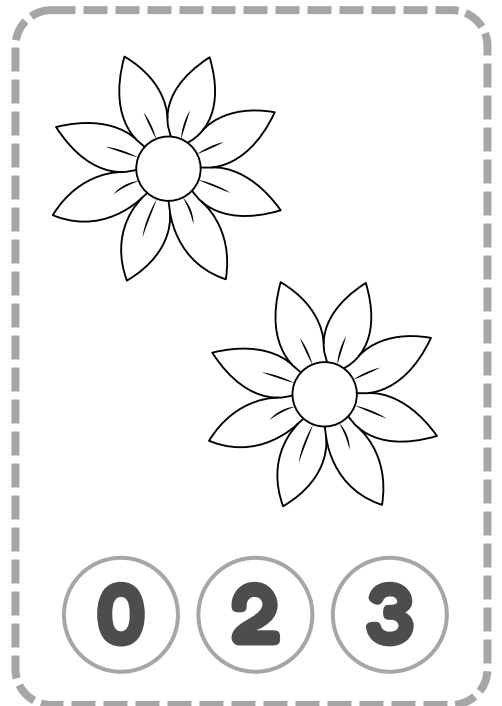

0 2 3